

175
CELEBRATING
OVER 175 YEARS OF
QUALITY & VALUE

MACHINED TIMBER PRODUCTS

One of the most extensive ranges of softwood products available, ranging from carcassing through to high quality small mouldings

 **HOWARTH TIMBER
& BUILDING SUPPLIES**

The Company

Just what you need, just when you need it



Arbor Forest Products have been setting the highest standards in the Timber Trading Industry for decades.

Standards in the quality of product, standards in the continuity of supply and standards in every aspect of customer service and support.

With a vast throughput of over 200,000m³ of quality timber supplied annually to the Distributor, Merchant and Industrial sectors, you may be assured of the most competitive pricing structures.



The Arbor Forest Products dedicated Timber Terminal is the largest privately owned port of its kind in the UK. Adjacent to which is a strategically placed mill facility which resets production benchmarks by providing the company with a machining capacity of over 35 million metres per annum.

It is therefore unsurprising that recent analyses revealed a reassuring 97.5% of products were in stock everytime. Even more impressive is this applies to the UK's largest product range by both width and depth of products offered.

With clearly defined grades and all pieces length stamped for ease of identification, the Arbor Forest Products range is so comprehensive it sets the standard for others to follow.

To support customers nationwide comes the Industry's most sophisticated logistics provision, delivering a minimum of 2-3 times each week to each trading business.

Delivering just what is needed,
when it is needed.

In addition to machined goods, uniquely constructed supply agreements can be offered on one of the widest ranges available including:

Arbordeck

- Softwood, Hardwood and low slip deck board options
- Spindles
- Newels
- Infill panels
- Handrails
- Brackets, Finials, Stair Stringers & Treatments
- Trex composite decking

Structural Carcassing products

- Kiln dried eased four edges c16/c24 treated and untreated
- CLS
- Scant
- Roofing Battens
- Complete fencing range

Sawn Joinery Timber

- Scandinavian
- Russian

Bespoke Machined Products

- Any grade, any profile

Bespoke Pressure Treated Products

Online Training Academy



Unique and the first of its kind, the Arbor Forest Products Online Training facility was developed both for the company's employees and for trading partners and their staff.

The aim of the Academy is to develop a wider knowledge, a better understanding, a greater commercial awareness of all aspects of the Timber Industry, providing participants with greater product understanding and more technical confidence.

Training Modules

There are currently three commercially based e-learning modules covering both product and technical training.

Introduction to Timber Part 1

By completing this module the student will learn about a wide variety of topics connected with timber such as sourcing, environmental benefits and timber's uses in the Building and Construction sector.

Introduction to Timber Part 2

Within this module the student will learn about a wide variety of topics connected with timber such as maintaining timber stocks to maximise profits, formulas and calculations to work out timber sizes, areas and how to price timber mouldings and profiles. Also covered in this section are timber preservation and how timber is strength graded.

Arbordeck

On completion of this module the student will gain a deeper understanding of timber decking, Arbordeck products and profiles such as deck boards, caps and handrails, newel posts, spindles and the preservative treatment process used in the production of Arbordeck products.

Classroom Based Training

To compliment the online academy the company is committed to maintaining an ongoing classroom based training programme tutored by the company's own training manager.



Inherent in Arbor Forest Products philosophy is commitment to the sustainability of woodland and forest. Throughout our entire trading operations we practice the most responsible environmental policies.

Environmental Responsibility



The Mill Facility



At 17m long and 3m diameter the new treatment vessel is capable of treating over 40m³ in one charge.



The multi million pound mill facility ensures our machined timber is of the highest standard with a range of more than 400 products.



The ultra modern mill is capable of processing more than 35 million metres of timber each year ensuring continuity of supply.

At the heart of the Arbor Forest Products operation is the state of the art mill facility.

Boasting the most modern machining facility in the UK, four machining lines provide quality finished product and total flexibility irrespective of large or small quantities, large or small sections.

The latest machine installed has a running speed of 250 metres per minute and incorporates 10 planing heads with up to 16 knives per block ensuring the machine is both the fastest and the most efficient in the country.

Mixed Loads?

Not a problem for Arbor Forest Products. Just tell us what you want and when you need it.

We'll deliver on one lorry to save time, money and the environment.



Skirting

CHAMFERED & ROUND / PENCIL RND REVERSIBLE

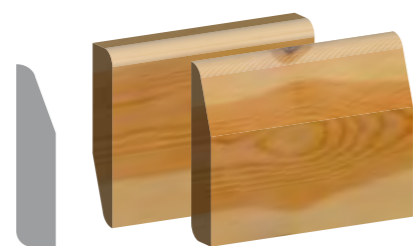

Size (mm)	Code	Grade	1m ³	1/2 m ³	Loose
19 x 75	s019075CP1	2	✓		✓
19 x 100	s019100CPUH	1		✓	✓
19 x 100	s019100CP2	2	✓	✓	✓
19 x 125	s019125CP2	2	✓		✓
19 x 150	s019150CP1H	2		✓	✓
25 x 150	s025150CP2	3	✓	✓	

CHAMF & ROUND / BULLNOSED REVERSIBLE

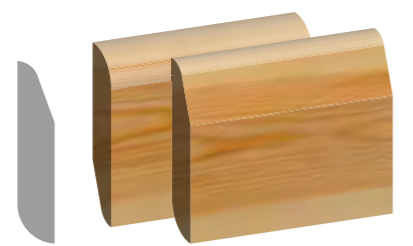

Size (mm)	Code	Grade	1m ³	1/2 m ³	Loose
19 x 75	s019075CB1H	2		✓	✓
19 x 100	s019100CB2	2	✓	✓	✓
19 x 125	s019125CB2	2	✓		

BULLNOSED SINGLESIDED

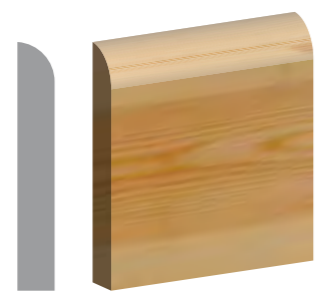

Size (mm)	Code	Grade	1m ³	1/2 m ³	Loose
19 x 100	s019100BU2	2	✓		

CHAMFERED & ROUND SINGLE SIDED

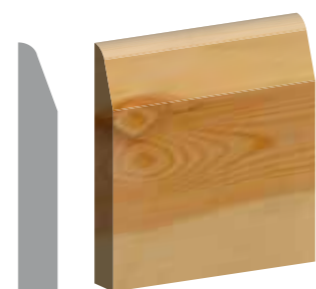

Size (mm)	Code	Grade	1m ³	1/2 m ³	Loose
19 x 100	s019100CR2	2	✓		

CHAMFERED & ROUND / OVOLO REVERSIBLE

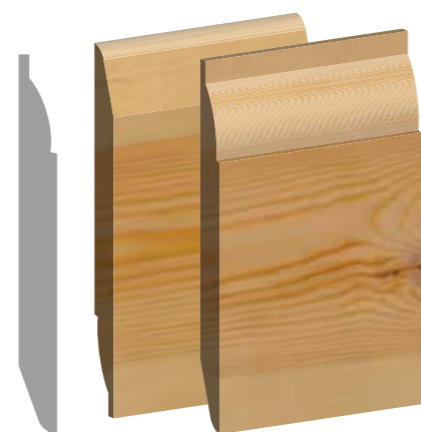

Size (mm)	Code	Grade	1m ³	1/2 m ³	Loose
19 x 150	mrs019150vcu	1			✓
25 x 150	s025150VCUH	1		✓	✓
25 x 150	s025150VC2	3	✓	✓	

TORUS / OGEE REVERSIBLE

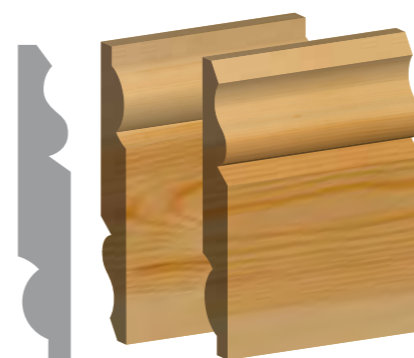

Size (mm)	Code	Grade	1m ³	1/2 m ³	Loose
19 x 125	s019125TG2	2	✓		
25 x 125	s025125TG1	2	✓	✓	✓
25 x 125	s025125TG2	3	✓		
25 x 150	s025150TGUH	1		✓	✓
25 x 150	s025150TG1	2	✓	✓	✓
25 x 150	s025150TG2	3	✓		
25 x 175	s025175tgu	1	✓	✓	✓
25 x 175	s025175TG1	2	✓	✓	✓
25 x 175	s025175TG2	3	✓		
25 x 225	s025225TG1H	2		✓	✓

TORUS SINGLE SIDED

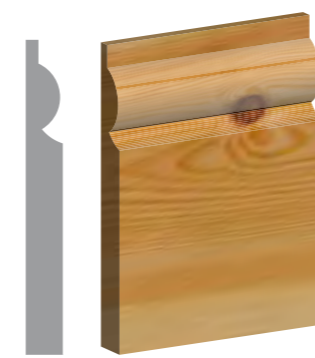

Size (mm)	Code	Grade	1m ³	1/2 m ³	Loose
19 x 125	s019125HT2	2	✓		
25 x 125	s025125HT2	3	✓		
25 x 150	s025150HT2	3	✓		
25 x 175	s025175HT2	3	✓		

Skirting

TORUS / LAMBS TONGUE REVERSIBLE

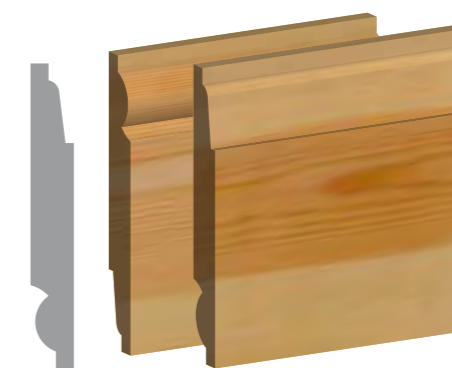

Size (mm)	Code	Grade	1m ³	1/2 m ³	Loose
19 x 125	s019125TV2	2	✓		
25 x 125	s025125TV1	2	✓	✓	
25 x 125	s025125TV2	3	✓	✓	
25 x 150	s025150TV1	2	✓		✓
25 x 175	s025175TV1	2	✓	✓	
25 x 175	s025175TV2	3	✓		

TORUS / OVOLO REVERSIBLE



Size (mm)	Code	Grade	1m ³	1/2 m ³	Loose
25 x 225	s025225TVUH	2		✓	✓

1 GRADE 1 - Unsorted Redwood from Siberia / Scandinavia

2 GRADE 2 - Scandinavian 5ths Redwood
(Original boards used for 25mm sections)

3 GRADE 3 - Swedish 5ths Redwood
(Relax kilned boards used for 25mm)

4 GRADE 4 - Russian 4ths Redwood
(Original boards used for 25mm sections)

5 GRADE 5 - Scandinavian S/F Whitewood
(Original boards used for 22mm sections)

6 GRADE 6 - Scandinavian 6th Whitewood
(Original boards used for 22mm sections)

Architraves

CHAMFERED & ROUND



Size (mm)	Code	Grade	1m ³	1/2 m ³	Loose
19 x 50	mrs019050CRU	1			✓
19 x 50	s019050CR1	2		✓	✓
*19 x 50	s019050CR21H	2		✓	
19 x 63	s019063CRUH	1		✓	✓
19 x 75	s019075CRUH	1		✓	✓

BULLNOSED



Size (mm)	Code	Grade	1m ³	1/2 m ³	Loose
19 x 50	s019050BU1	2	✓	✓	✓
*19 x 50	s019050BU21H	2		✓	
19 x 75	s019075BU1	2	✓	✓	✓

PENCIL ROUND



Size (mm)	Code	Grade	1m ³	1/2 m ³	Loose
19 x 50	mrs019050pru	1			✓
19 x 50	s019050PR1H	2		✓	✓
*19 x 50	s019050PR21H	2		✓	
19 x 75	s019075CRUH	1		✓	✓
19 x 75	s019075PR1	2	✓	✓	✓

TORUS

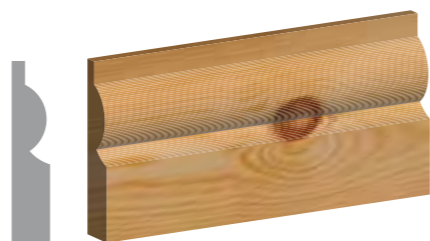

Size (mm)	Code	Grade	1m ³	1/2 m ³	Loose
19 x 75	s019075HT1	2	✓		
25 x 75	s025075HT1	2	✓	✓	✓

OGEE

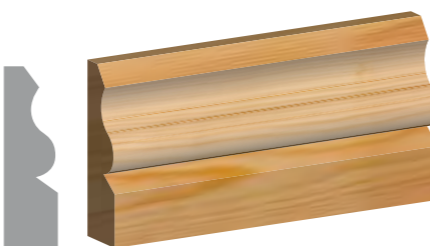

Size (mm)	Code	Grade	1m ³	1/2 m ³	Loose
19 x 50	m0190500GU	1			✓
25 x 63	s025063HGU	1		✓	✓
25 x 63	s025063HG2H	2		✓	✓
25 x 75	s025075HGUH	1		✓	✓
25 x 75	s025075HG1	2	✓	✓	✓
*25 x 75	s025075HG21H	2		✓	

1 **GRADE 1** - Unsorted Redwood from Siberia / Scandinavia

2 **GRADE 2** - Scandinavian 5ths Redwood
(Original boards used for 25mm sections)

3 **GRADE 3** - Swedish 5ths Redwood
(Relax kilned boards used for 25mm)

4 **GRADE 4** - Russian 4ths Redwood
(Original boards used for 25mm sections)

5 **GRADE 5** - Scandinavian S/F Whitewood
(Original boards used for 22mm sections)

6 **GRADE 6** - Scandinavian 6th Whitewood
(Original boards used for 22mm sections)

Architraves

LAMBS TONGUE



Size (mm)	Code	Grade	1m ³	1/2 m ³	Loose
25 x 75	s025075HV1	2	✓	✓	✓
*25 x 75	s025075HV21H	2		✓	

OVOLO



Size (mm)	Code	Grade	1m ³	1/2 m ³	Loose
25 x 63	s025063LVUH	1		✓	✓
25 x 63	s025063LVUH	2		✓	✓
25 x 75	s025075LVUH	1		✓	✓
25 x 75	s025075LV2H	2		✓	

OGEE AND BEADED

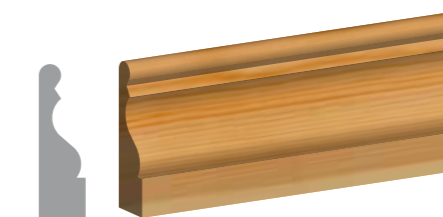

Size (mm)	Code	Grade	1m ³	1/2 m ³	Loose
25 x 75	m0250750BU	1			✓

BELGRAVE

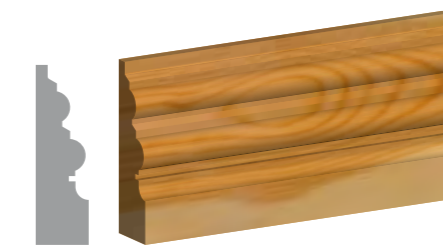

Size (mm)	Code	Grade	1m ³	1/2 m ³	Loose
25 x 75	m025075WBP	1			✓

***Special 2.1mtr Lengths**

Not a problem for Arbor Forest Products.

Cladding

T & G SHIPLAP

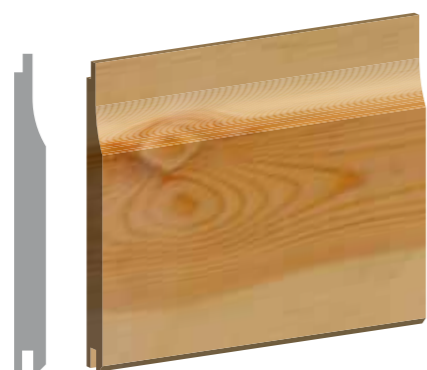

Size (mm)	Code	Grade	1m ³	1/2 m ³	Loose
16.7 x 125	c016125SG2	4	✓		
19 x 125	c019125SG2	4	✓		

REBATED SHIPLAP

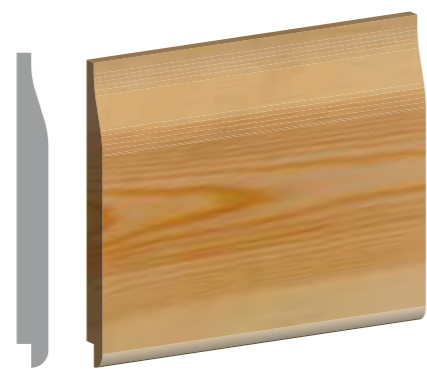

Size (mm)	Code	Grade	1m ³	1/2 m ³	Loose
16.7 x 125	c016125SG1	2	✓	✓	✓
16.7 x 125	c016125SGR	4	✓		
19 x 125	c019125SG1R	2	✓	✓	✓

PTGV BEADED - MATCHINGS



Size (mm)	Code	Grade	1m ³	1/2 m ³	Loose
13 x 100	c013100B24	2	✓		

PTGV1SIDE - MATCHINGS



Size (mm)	Code	Grade	1m ³	1/2 m ³	Loose	Length
13 x 100	c013100M24	2	✓		✓	2.4mtrs
13 x 100	c013100M30	2	✓			3.0mtrs
13 x 100	c013100M36	2	✓			3.6mtrs
16.7 x 100	c016100MG1	2	✓		✓	
16.7 x 125	c016125MA1	2	✓			
16.7 x 125	c016125MG2	4	✓			
19 x 100	c019100MG1	2	✓	✓	✓	
19 x 100	c019100MG2	4	✓			
19 x 125	c019125MG1	2	✓		✓	
19 x 125	c019125MG2	4	✓			
25 x 125	c025125MG2	4	✓			

PTGV2SIDE - MATCHINGS



Size (mm)	Code	Grade	1m ³	1/2 m ³	Loose
25 x 100	c025100XG1	3	✓		✓
25 x 125	c025125XG1	3	✓		✓

SQUARE EDGED FLOORING

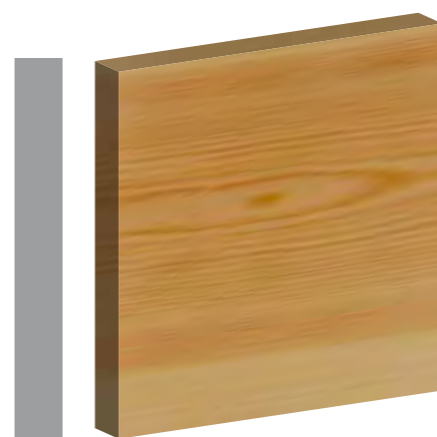

Size (mm)	Code	Grade	1m ³	1/2 m ³	Loose
22 x 150	p022150WW	5	✓		
22 x 150	p022150RW	5	✓		

Flooring

PTG FLOORING

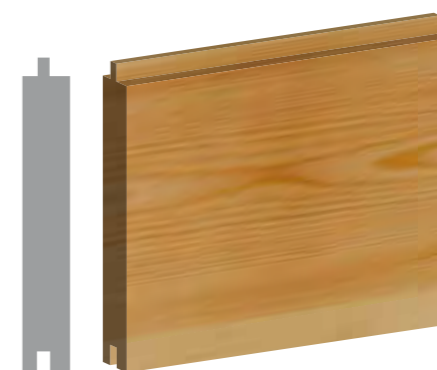

Size (mm)	Code	Grade	1m ³	1/2 m ³	Loose
22 x 125	f022125WW	5	✓		✓
22 x 125	f0221256W	6	✓		
22 x 150	f022150WW	5	✓		✓
22 x 150	f022150EG	6	✓		
25 x 125	f025125A1	2	✓		
25 x 125	f025150RW	4	✓		
25 x 150	f025150A1	2	✓		✓
25 x 150	f025150RW	4	✓		

1 **GRADE 1** - Unsorted Redwood from Siberia / Scandinavia

2 **GRADE 2** - Scandinavian 5ths Redwood
(Original boards used for 25mm sections)

3 **GRADE 3** - Swedish 5ths Redwood
(Relax kilned boards used for 25mm)

4 **GRADE 4** - Russian 4ths Redwood
(Original boards used for 25mm sections)

5 **GRADE 5** - Scandinavian S/F Whitewood
(Original boards used for 22mm sections)

6 **GRADE 6** - Scandinavian 6th Whitewood
(Original boards used for 22mm sections)

Mouldings

ASTRAGAL

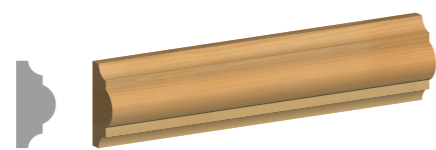

Size (mm)	Code	Grade	1m ³	1/2 m ³	Loose
13 x 25	m013025AG	1			✓
19 x 38	m019038AG	1≠			✓

OGEE PANAL MOULD

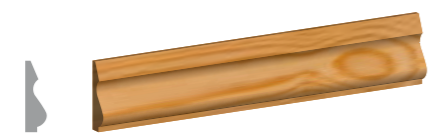

Size (mm)	Code	Grade	1m ³	1/2 m ³	Loose
13 x 25	m0130250P	1			✓
13 x 32	m0130320P	1			✓
13 x 38	m0130380P	1			✓
16 x 38	m0160380P	1			✓
19 x 50	m0190500P	1			✓

CORNICE

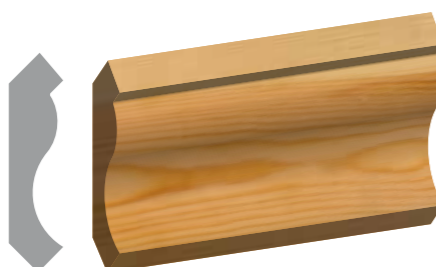

Size (mm)	Code	Grade	1m ³	1/2 m ³	Loose
25 x 88	m025088WTC	1			✓

OVOLO STOP



Size (mm)	Code	Grade	1m ³	1/2 m ³	Loose
16 x 25	m016025OV	1			✓
16 x 38	m016038OV	1			✓
16 x 50	m016050OV	1			✓

OVOLO GLAZING BEAD



Size (mm)	Code	Grade	1m ³	1/2 m ³	Loose
13 x 16	m013016OV	1			✓
13 x 19	m013019OV	1			✓

STAFF BEAD



Size (mm)	Code	Grade	1m ³	1/2 m ³	Loose
19 x 25	m019025SB	1			✓
19 x 32	m019032SB	1			✓

PARTING BEAD



Size (mm)	Code	Grade	1m ³	1/2 m ³	Loose
13 x 25	m013025PB	1			✓
13 x 32	m013032PB	1			✓

HALF ROUND



Size (mm)	Code	Grade	1m ³	1/2 m ³	Loose
13 x 25	m013025HR	1			✓

TRANSOM DRIP



Size (mm)	Code	Grade	1m ³	1/2 m ³	Loose
32 x 38	m032038WTD	1			✓

PICTURE RAIL

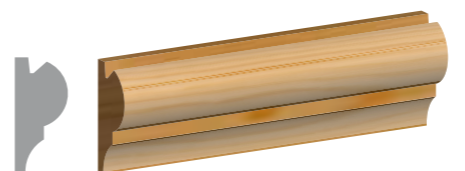

Size (mm)	Code	Grade	1m ³	1/2 m ³	Loose
25 x 50	m025050PRU	1			✓

SCOTIA PICTURE RAIL

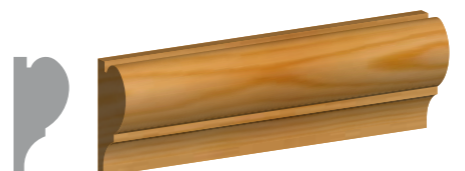

Size (mm)	Code	Grade	1m ³	1/2 m ³	Loose
25 x 50	m025050RSC	1			✓

Mouldings

ASTRAGAL DADO

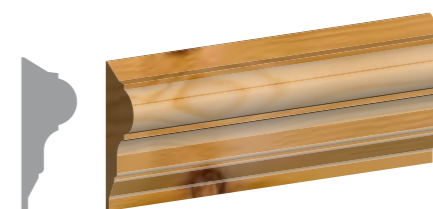

Size (mm)	Code	Grade	1m ³	1/2 m ³	Loose
25 x 63	m025063ADU	1			✓

TRADITIONAL DADO

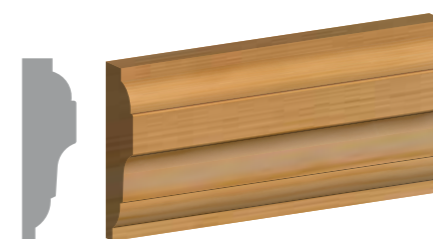

Size (mm)	Code	Grade	1m ³	1/2 m ³	Loose
25 x 75	m025075TDU	1			✓

DADO RAIL

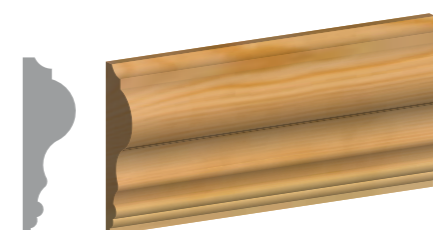

Size (mm)	Code	Grade	1m ³	1/2 m ³	Loose
25 x 75	r025075HDUH	1		✓	✓

1 GRADE 1 - Unsorted Redwood from Siberia / Scandinavia

2 GRADE 2 - Scandinavian 5ths Redwood
(Original boards used for 25mm sections)

3 GRADE 3 - Swedish 5ths Redwood
(Relax kilned boards used for 25mm)

4 GRADE 4 - Russian 4ths Redwood
(Original boards used for 25mm sections)

5 GRADE 5 - Scandinavian S/F Whitewood
(Original boards used for 22mm sections)

6 GRADE 6 - Scandinavian 6th Whitewood
(Original boards used for 22mm sections)

Mouldings

WINDOW BOARD



Size (mm)	Code	Grade	1m ³	1/2 m ³	Loose
32 x 225	b032225HQBH	1		✓	✓
32 x 150	m032150QWB	1			✓

WINDOW BOARD NOSING



Size (mm)	Code	Grade	1m ³	1/2 m ³	Loose
32 x 50	m032050WN	1			✓

REBATE BASERAIL (35MM REBATE)

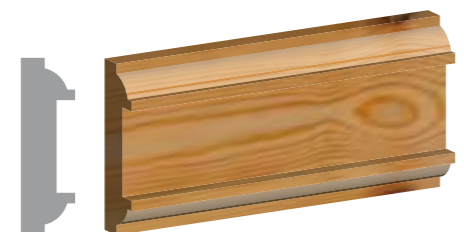

Size (mm)	Code	Grade	1m ³	1/2 m ³	Loose
25 x 75	m025075HRB	1			✓

MOPSTICK

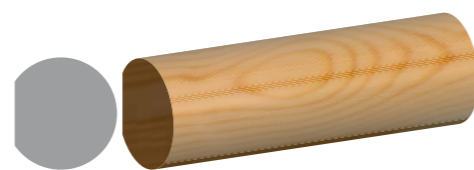

Size (mm)	Code	Grade	1m ³	1/2 m ³	Loose
50 x 50	r050050HMSH	1		✓	✓

REBATE CROWN (35MM REBATE)

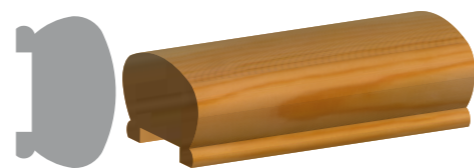

Size (mm)	Code	Grade	1m ³	1/2 m ³	Loose
50 x 75	m050075HRC	1			✓

CROWN

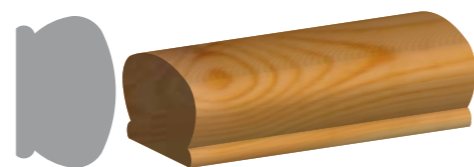

Size (mm)	Code	Grade	1m ³	1/2 m ³	Loose
50 x 75	m050075HCR	1			✓

WALLFIX HANDRAIL

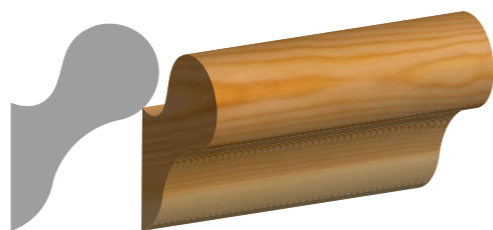

Size (mm)	Code	Grade	1m ³	1/2 m ³	Loose
50 x 115	m050115HWF	1			✓

Mouldings

CILL

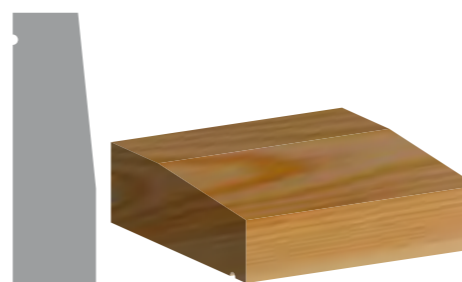

Size (mm)	Code	Grade	1m ³	1/2 m ³	Loose
50 x 150	m050150WSC	1			✓
75 x 150	m075150WSC	1			✓

WEATHER BAR



Size (mm)	Code	Grade	1m ³	1/2 m ³	Loose
50 x 63	m050063WDW	1			✓

SCOTIA

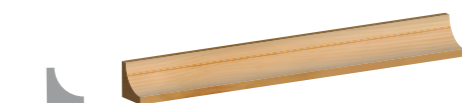

Size (mm)	Code	Grade	1m ³	1/2 m ³	Loose
25 x 25	m025025Sc	1			✓
38 x 38	m038038SC	1			✓

QUADRANT



Size (mm)	Code	Grade	1m ³	1/2 m ³	Loose
13 x 13	m013013QD	1			✓
16 x 16	m016016QD	1			✓
19 x 19	m019019QD	1			✓
25 x 25	m025025QD	1			✓

TORUS MOULD

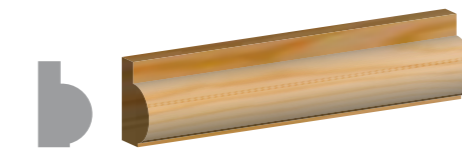

Size (mm)	Code	Grade	1m ³	1/2 m ³	Loose
25 x 38	m025038TM	1			✓

1 **GRADE 1** - Unsorted Redwood from Siberia / Scandinavia

2 **GRADE 2** - Scandinavian 5ths Redwood
(Original boards used for 25mm sections)

3 **GRADE 3** - Swedish 5ths Redwood
(Relax kilned boards used for 25mm)

4 **GRADE 4** - Russian 4ths Redwood
(Original boards used for 25mm sections)

5 **GRADE 5** - Scandinavian S/F Whitewood
(Original boards used for 22mm sections)

6 **GRADE 6** - Scandinavian 6th Whitewood
(Original boards used for 22mm sections)

Casing Linings

REVERSIBLE HEAD TO SUIT 2'3" / 2'6" DOORS

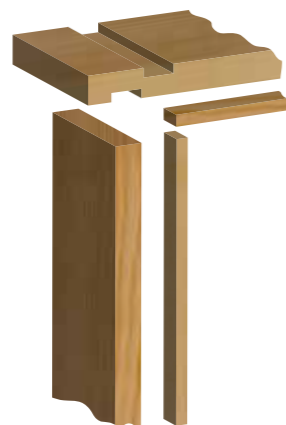

Size (mm)	Code	Stop	1m ³	1/2 m ³	Loose
32 x 115	d032115LS	x		✓	
32 x 140	d032140LS	x		✓	
*32 x 115	d032115SS	✓		✓	
*32 x 140	d032140SS	✓		✓	

REVERSIBLE HEAD TO SUIT 2'6" / 2'9" DOORS

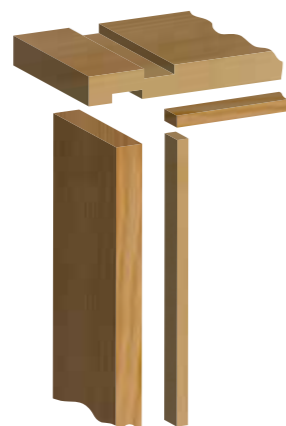

Size (mm)	Code	Stop	1m ³	1/2 m ³	Loose
32 x 115	d032115L9	x		✓	
32 x 140	d032140L9	x		✓	
*32 x 115	d032115S9	✓		✓	
*32 x 140	d032140S9	✓		✓	
32 x 175	d032175L9	x		✓	

5.1 MTR LENGTHS

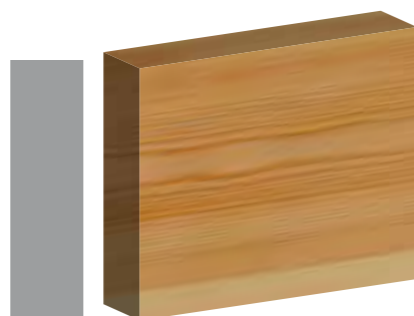

Size (mm)	Code	Grade	1m ³	1/2 m ³	Loose
32 x 115	d032115LN	5	✓		
32 x 115	d032115LNR	2	✓		✓
32 x 140	d032140LN	5	✓		
32 x 140	d032140LNR	2	✓		✓
32 x 150	d032150LNR	2	✓	✓	✓
32 x 175	d032175LNR	2	✓		✓
38 x 175	d038175LNR	2	✓		

DOOR CASINGS Rebated & Trenched to suit 2' 6" Doors

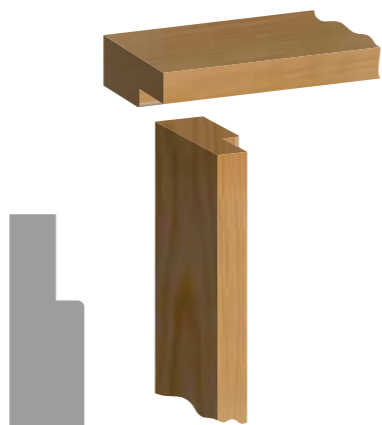

Size (mm)	Code	Grade	1m ³	1/2 m ³	Loose
38 x 100	d038100TR			✓	
38 x 115	d038115TR			✓	
38 x 125	d038125TR			✓	
38 x 140	d038140TR			✓	
38 x 150	d038150TR			✓	

DOOR CASINGS Rebated & Trenched to suit 2' 9" Doors, CR 2' 6" Doors



Size (mm)	Code	Grade	1m ³	1/2 m ³	Loose
38 x 100	d038100T9			✓	
38 x 115	d038115T9			✓	
38 x 125	d038125T9			✓	
38 x 140	d038140T9			✓	
38 x 150	d038150T9			✓	

FIRE CHECK DOOR CASINGS REDWOOD BWF Certifire - FD30 Accredited

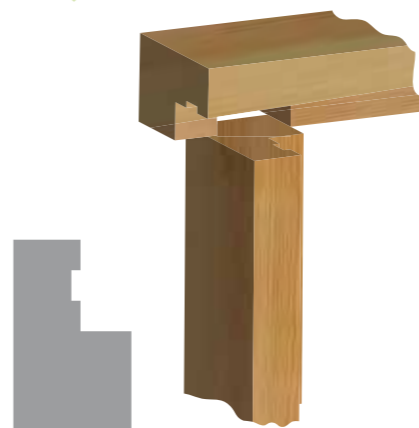

Size (mm)	Code	Grade	1m ³	1/2 m ³	Loose
50 x 115	d050115FC		✓		
50 x 140	d050140FC		✓		
50 x 150	d050150FC		✓		
63 x 100	d063100FC		✓		
63 x 115	d063115FC		✓		
63 x 140	d063140FC		✓		
63 x 150	d063150FC		✓		

Casing Linings

FIRE CHECK DOOR LININGS REDWOOD BWF Certifire - FD30 Accredited Trenched to suit 2' 3" / 2'6" Reversible

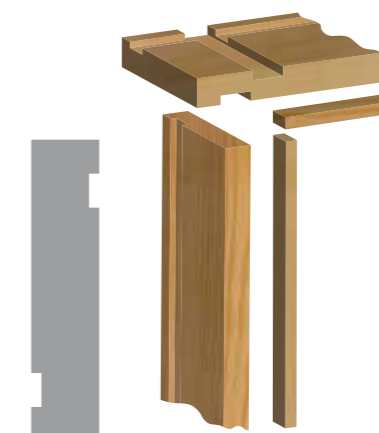

Size (mm)	Code	Stop	1m ³	1/2 m ³	Loose
*38 x 115	d038115FC3	✓	✓		
*38 x 140	d038140FC3	✓	✓		

FIRE CHECK DOOR LININGS REDWOOD BWF Certifire - FD30 Accredited Trenched to suit 2' 6" / 2'9" Reversible



Size (mm)	Code	Stop	1m ³	1/2 m ³	Loose
*38 x 115	d038115FC9	✓	✓		
*38 x 140	d038140FC9	✓	✓		

* Supplied with 12 x 32f stop.

1 GRADE 1 - Unsorted Redwood from Siberia / Scandinavia

2 GRADE 2 - Scandinavian 5ths Redwood (Original boards used for 25mm sections)

3 GRADE 3 - Swedish 5ths Redwood (Relax kilned boards used for 25mm)

4 GRADE 4 - Russian 4ths Redwood (Original boards used for 25mm sections)

5 GRADE 5 - Scandinavian S/F Whitewood (Original boards used for 22mm sections)

6 GRADE 6 - Scandinavian 6th Whitewood (Original boards used for 22mm sections)

Bulk Garden Shed Material

SCANDINAVIAN / RUSSIAN REDWOOD PTGV 1 SIDE

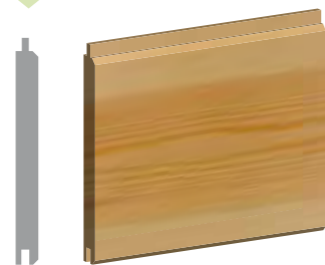

Size (mm)	Code	Grade	Full Pack	Pack Size
16.7 x 125	q16125MG2	✓	✓	2000 mtrs
19 x 100	q19100MG2	✓	✓	2100 mtrs
19 x 125	q19125MG2	✓	✓	1600 mtrs
25 x 125	q25125MG2	✓	✓	1280 mtrs

SCANDINAVIAN / RUSSIAN WHITEWOOD PTGV 1 SIDE

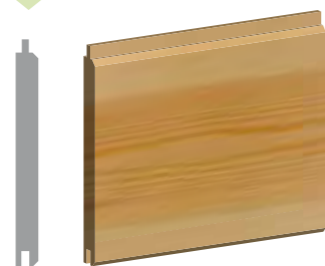

Size (mm)	Code	Grade	Full Pack	Pack Size
16.7 x 125	q16125MSW	✓	✓	2000 mtrs

SCANDINAVIAN / RUSSIAN REDWOOD PTGV 2 SIDE

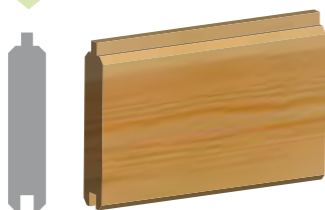

Size (mm)	Code	Grade	Full Pack	Pack Size
25 x 100	q25100XG1	✓	✓	800 mtrs
25 x 125	q25125XG1	✓	✓	640 mtrs

SCANDINAVIAN / RUSSIAN REDWOOD SHIPLAP

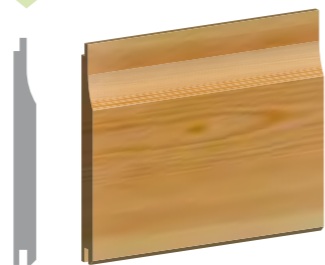

Size (mm)	Code	Grade	Full Pack	Pack Size
16.7 x 125	q16125SE2	✓	✓	2000 mtrs
19 x 125	q19125SE2	✓	✓	1600 mtrs
25 x 125		✓	✓	TO ORDER

SCANDINAVIAN / RUSSIAN WHITEWOOD SHIPLAP

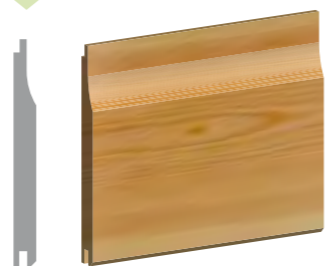

Size (mm)	Code	Grade	Full Pack	Pack Size
16.7 x 125	q16125SSW	✓	✓	2000 mtrs

SCANDINAVIAN / RUSSIAN REDWOOD REBATED SHIPLAP

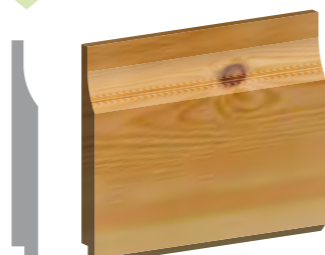

Size (mm)	Code	Grade	Full Pack	Pack Size
16.7 x 125	q16125SGR	✓	✓	2000 mtrs
19 x 125	q19125RB2	✓	✓	1600 mtrs

SCANDINAVIAN / RUSSIAN REDWOOD T&G LOG BOARD

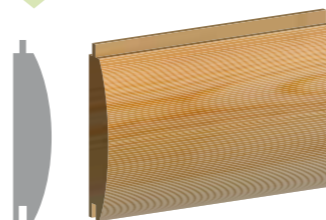

Size (mm)	Code	Grade	Full Pack	Pack Size
19 x 100	q19100LG2	✓	✓	1300 mtrs
25 x 100	q25100LG2	✓	✓	
38 x 150		✓	✓	TO ORDER

SCANDINAVIAN / RUSSIAN REDWOOD REBATED LOG BOARD

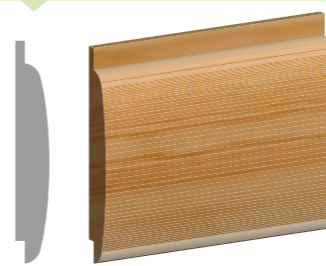

Size (mm)	Code	Grade	Full Pack	Pack Size
25 x 125	q25125LR2	✓	✓	800 mtrs

SCANDINAVIAN / RUSSIAN RED WHITE EASED EDGE FRAMING



Size (mm)	Code	Grade	Full Pack	Pack Size
32 x 50	q3250FRA	✓	✓	2000 mtrs
38 x 50	q3850ECO	✓	✓	1800 mtrs
50 x 50	q5050FRA	✓	✓	1400 mtrs

SCANDINAVIAN / RUSSIAN REDWOOD T&G DOUBLE LOG BOARD

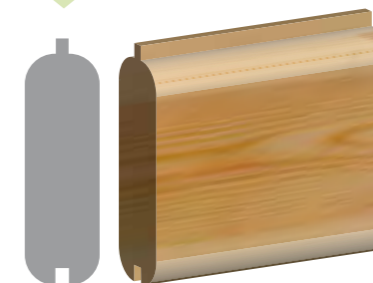

Size (mm)	Code	Grade	Full Pack	Pack Size
50 x 150		✓	✓	TO ORDER

SCANDINAVIAN / RUSSIAN REDWOOD FASCIA BOARD EASED EDGE



Size (mm)	Code	Grade	Full Pack	Pack Size
16 x 100	q3250FRA	✓	✓	TO ORDER



1 GRADE 1 - Unsorted Redwood from Siberia / Scandinavia

2 GRADE 2 - Scandinavian 5ths Redwood
(Original boards used for 25mm sections)

3 GRADE 3 - Swedish 5ths Redwood
(Relax kilned boards used for 25mm)

4 GRADE 4 - Russian 4ths Redwood
(Original boards used for 25mm sections)

5 GRADE 5 - Scandinavian S/F Whitewood
(Original boards used for 22mm sections)

6 GRADE 6 - Scandinavian 6th Whitewood
(Original boards used for 22mm sections)

Redwood PAR Sections

Whitewood PAR Sections

Size (mm)	Code	Grade	1m ³	1/2 m ³	Loose
13 x 25	m013025PU	1			✓
13 x 38	m013038PU	1			✓
13 x 50	m013050PU	1			✓
13 x 75	m013075PU	1			✓
13 x 100	m013100PU	1			✓
16 x 38	p016038PU	1		✓	✓
16 x 50	m016050PU	1			✓
19 x 25	m019025PU	1			✓
19 x 38	m019038PU	1			✓
19 x 50	m019050PU	1			✓
19 x 50	m019050P1	2			✓
19 x 75	p019075P1H	2		✓	✓
19 x 100	p019100P1H	2		✓	✓
19 x 125	p019125P1H	2		✓	✓
19 x 150	p019150p1	2		✓	✓
25 x 25	m025025PU	1			✓
25 x 25	m025025P1	2			✓
25 x 38	m025038PU	1			✓
25 x 38	p025038P1H	2		✓	✓
25 x 50	p025050PU	1	✓		✓
25 x 50	p025050A1	2	✓	✓	✓
25 x 50	p025050B1	3	✓		
25 x 50	p025050G2	4	✓		
25 x 75	p025075PU	1	✓		✓
25 x 75	p025075A1	2	✓	✓	✓
25 x 75	p025075B1	3	✓		
25 x 75	p025075G2	4	✓		
25 x 100	p025100PU	1	✓		
25 x 100	p025100A1	2	✓	✓	✓
25 x 100	p025100B1	3	✓		
25 x 100	p025100G2	4	✓		
25 x 125	p025125PU	1	✓		✓
25 x 125	p025125A1	2	✓	✓	✓
25 x 125	p025125B1	3	✓		
25 x 125	p025125G2	4	✓		
25 x 150	p025150PU	1	✓		✓
25 x 150	p025150A1	2	✓	✓	✓
25 x 150	p025150B1	3	✓		
25 x 150	p025150G2	4	✓		
25 x 175	p025175PU	1	✓		✓
25 x 175	p025175A1	2	✓	✓	✓
25 x 175	p025175B1	3	✓		
25 x 175	p025175G2	4	✓		
25 x 200	p025200PU	1	✓		✓
25 x 200	p025200A1	2	✓	✓	✓
25 x 200	p025200G2	4	✓		

Size (mm)	Code	Grade	1m ³	1/2 m ³	Loose
25 x 225	p025225PU	1	✓		✓
25 x 225	p025225A1	2	✓	✓	✓
25 x 225	p025225G2	4	✓		
32 x 32	m032032PU	1			✓
32 x 38	p032038PUH	1		✓	✓
32 x 50	p032050PUH	1		✓	✓
32 x 75	p032075A1H	2		✓	
32 x 100	p032100A1H	2		✓	
32 x 150	d032150lnr	2	✓	✓	✓
32 x 225	p032225A1	2	✓		✓
38 x 38	p038038A1H	2		✓	✓
38 x 50	p038050PUH	1		✓	
38 x 50	p038050A1H	2		✓	✓
38 x 50	p038050G2	4	✓		
38 x 75	p038075A1H	2		✓	✓
38 x 75	p038075G2	4	✓		
38 x 100	p038100A1	2	✓	✓	✓
38 x 125	p038125A1	2	✓	✓	✓
38 x 150	p038150A1	2	✓	✓	✓
38 x 150	p038150G2	4	✓		
38 x 225	p038225PU	1		✓	
38 x 225	p038225A1	2	✓		✓
50 x 50	p050050PU	1	✓		✓
50 x 50	p050050A1	2	✓	✓	✓
50 x 50	p050050G2	4	✓		
50 x 75	p050075PU	1	✓		
50 x 75	p050075A1	2	✓	✓	✓
50 x 75	p050075G2	4	✓		
50 x 100	p050100PU	1	✓		
50 x 100	p050100A1	2	✓	✓	✓
50 x 100	p050100G2	4	✓		
50 x 125	p050125A1	2	✓		✓
50 x 150	p050150PU	1	✓		✓
50 x 150	p050150A1	2	✓	✓	✓
50 x 150	p050150G2	4	✓		
50 x 225	p050225PUH	1		✓	
50 x 225	p050225A1H	2		✓	✓
75 x 75	p075075PU	1	✓		
75 x 75	p075075A1	2	✓	✓	✓
75 x 100	p075100PU	1	✓		
75 x 100	p075100A1	2	✓	✓	✓
100 x 100	p100100A1	1	✓	✓	✓

Size (mm)	Code	Grade	1m ³	1/2 m ³	Loose
22 x 50	p022050WW	5	✓		
22 x 75	p022075WW	5	✓		
22 x 100	p022100WW	5	✓		
22 x 125	p022125WW	5	✓		
22 x 150	p022150WW	5	✓		
22 x 150	p022150RW	6	✓		

Size (mm)	Code	Grade	1m ³	1/2 m ³	Loose
22 x 175	p022175WW	5	✓		
22 x 200	p022200WW	5	✓		
22 x 225	p022225WW	5	✓		
25 x 275	p025275WW	5	✓		✓
32 x 275	p032275WW	5	✓		✓
38 x 275	p038275WW	5	✓		✓

PAR Sections

22

23



1 GRADE 1 - Unsorted Redwood from Siberia / Scandinavia

2 GRADE 2 - Scandinavian 5ths Redwood
(Original boards used for 25mm sections)

3 GRADE 3 - Swedish 5ths Redwood
(Relax kilned boards used for 25mm)

4 GRADE 4 - Russian 4ths Redwood
(Original boards used for 25mm sections)

5 GRADE 5 - Scandinavian S/F Whitewood
(Original boards used for 22mm sections)

6 GRADE 6 - Scandinavian 6th Whitewood
(Original boards used for 22mm sections)

Primed MDF Mouldings

CHAMFERED & ROUND - 4.4MTRS



Size (mm)	Code	Grade	1m ³	1/2 m ³	Loose
15 x 44	AM0150044CR			✓	
15 x 68	AM0150068CR			✓	
15 x 94	AM0150094CR			✓	
18 x 144	AM0150144CR			✓	

ROUND 1 EDGE (9MM RAD) - 4.4MTRS



Size (mm)	Code	Grade	1m ³	1/2 m ³	Loose
15 x 44	AM015044PR			✓	
15 x 68	AM015068PR			✓	
15 x 94	AM015094PR			✓	
18 x 44	AM018044PR			✓	
18 x 68	AM018068PR			✓	
18 x 94	AM018094PR			✓	
18 x 144	AM018144PR			✓	

OGEE - 4.4MTRS

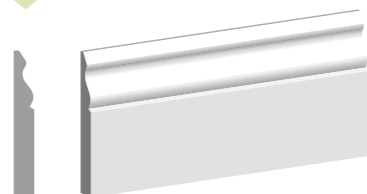

Size (mm)	Code	Grade	1m ³	1/2 m ³	Loose
18 x 57	AM018057OG			✓	
18 x 68	AM018068OG			✓	
18 x 119	AM018119OG			✓	
18 x 144	AM018144OG			✓	
18 x 168	AM018168OG			✓	
18 x 219	AM018219OG			✓	

TORUS - 4.4MTRS

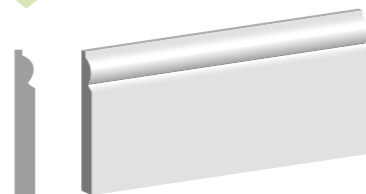

Size (mm)	Code	Grade	1m ³	1/2 m ³	Loose
18 x 57	AM018057TO			✓	
18 x 68	AM018068TO			✓	
18 x 119	AM018119TO			✓	
18 x 144	AM018144TO			✓	
18 x 168	AM018168TO			✓	
18 x 219	AM018219TO			✓	

OVOLO - 4.4MTRS

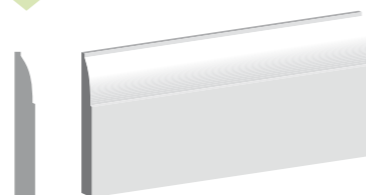

Size (mm)	Code	Grade	1m ³	1/2 m ³	Loose
18 x 68	AM018068OV			✓	
18 x 119	AM018119OV			✓	
18 x 144	AM018144OV			✓	
18 x 168	AM018168OV			✓	

N&T WINDOWBOARD - 3.66MTRS

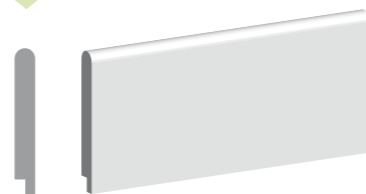

Size (mm)	Code	Grade	1m ³	1/2 m ³	Loose
25 x 194	AM025194WB			✓	
25 x 219	AM025219WB			✓	
25 x 244	AM025244WB			✓	
25 x 294	AM025294WB			✓	



All Arbor Forest Products mouldings are produced in one of the most sophisticated factories in Europe, which comes with the assurance of the highest quality and most exacting standards, with each piece machine sanded and twice primed.

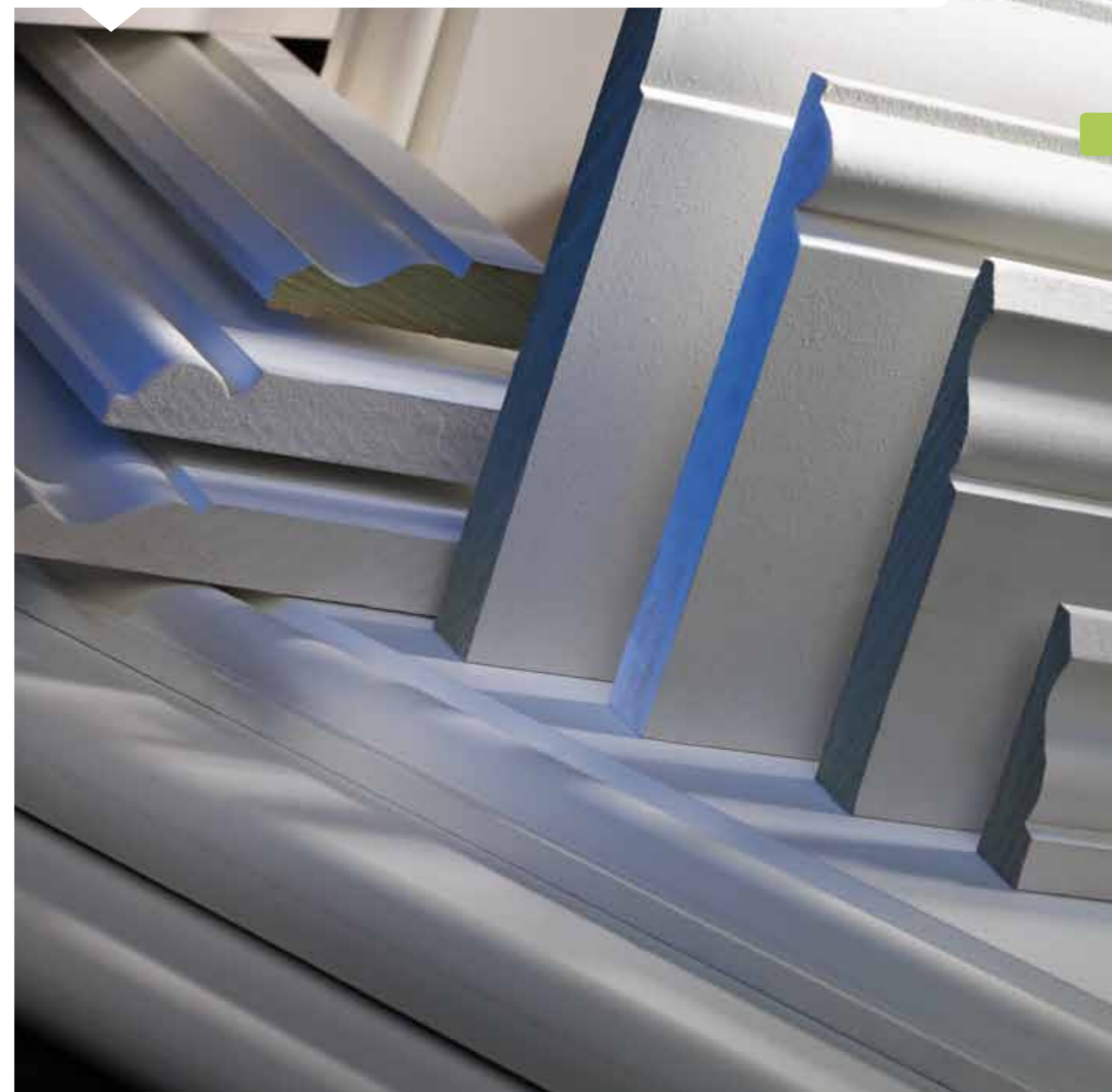



Performance with peace of mind built in.

Arbordeck softwood decking products are manufactured from high quality European redwoods which are sourced from northern latitudes. Arbordeck offers full chain of custody certification and is manufactured to the highest quality standards with one of the industry's most comprehensive range of product options and accessories.

With a full range of reseller support materials such as Brochures, Samples, Training & Technical Support, Arbordeck benefits from the largest of stockholdings and the industry unique mixed loads delivery service, nationwide everyday.

Contact Arbor Forest Products Ltd for further details:-

T: 01469 532300

E: sales@arborforestproducts.co.uk

W: www.arbordeck.co.uk



DeckMark™ is a quality assurance scheme introduced by the Timber Decking Association to confirm manufacturers compliance with Best Practice guidance and all relevant British Standards. For further information please contact the TDA on 01977 558147.



All timbers within the Arbordeck range are preservative treated with Osmose NatureWood under a controlled high pressure treatment cycle in accordance with best practice and specific technical data.



Imagine decking that won't fade, won't stain, won't rot and won't split – guaranteed!

Ideal for commercial or residential projects, Trex® is 95% made from recycled materials such as plastic and wood waste. Trex® recycles 1.5 billion shopping bags each year to produce one of the most environmentally focused and weather-resistant composite decking products on the market.

The finished product provides an extremely weather-resistant board which is hard to damage, won't warp or splinter, will never require staining or painting and will look as good in years to come as it does today.

- 25 year residential warranty (including fade & stain)
- 10 year commercial warranty (including fade & stain)

For Arbordeck literature please telephone 01469 532300



HOWARTH TIMBER & BUILDING SUPPLIES

THE UK'S LARGEST PRIVATELY OWNED AND OPERATED TIMBER
GROUP WITH BRANCHES LOCATED NATIONWIDE

NORTH WEST

Accrington	0330 119 3269	sales.accrington@howarth-timber.co.uk	BB5 0DN
Ashton	0330 119 3189	sales.ashton@howarth-timber.co.uk	OL7 0AG
Blackburn	0330 119 3239	sales.blackburn@howarth-timber.co.uk	BB1 3EE
Burnley	0330 119 3229	sales.burnley@howarth-timber.co.uk	BB10 1RZ
Bury	0330 119 3219	sales.bury@howarth-timber.co.uk	BL9 6AQ
Darwen	0330 119 3259	sales.darwen@howarth-timber.co.uk	BB3 2ES
Manchester	0330 119 3199	sales.manchester@howarth-timber.co.uk	M4 5HD
Oldham	0330 119 3179	sales.oldham@howarth-timber.co.uk	OL1 3LJ
Rochdale	0330 119 3209	sales.rochdale@howarth-timber.co.uk	OL16 2AA
Sale	0330 119 3169	sales.sale@howarth-timber.co.uk	M33 6LB

YORKS & Lincs

Barnsley	0330 119 2599	sales.barnsley@howarth-timber.co.uk	S75 2BL
Bradford	0330 119 2489	sales.bradford@howarth-timber.co.uk	WF15 8ER
Brighouse	0330 119 2419	sales.brighouse@howarth-timber.co.uk	HD6 1PE
Dewsbury	0330 119 2499	sales.dewsbury@howarth-timber.co.uk	WF13 2AF
Grimsby	0330 119 2559	sales.grimsby@howarth-timber.co.uk	DN32 9BA
Harrogate	0330 119 3139	sales.harrogate@howarth-timber.co.uk	HG1 4AU
Leeds	0330 119 3119	sales.leeds@howarth-timber.co.uk	LS9 0RA
Malton	0330 119 3129	sales.malton@howarth-timber.co.uk	YO17 6BT
Scunthorpe	0330 119 2549	sales.scunthorpe@howarth-timber.co.uk	DN15 6XH
Thorne	0330 119 2539	sales.thorne@howarth-timber.co.uk	DN8 5DY
Wakefield	0330 119 2589	sales.wakefield@howarth-timber.co.uk	WF1 5DW
York	0330 119 3159	sales.york@howarth-timber.co.uk	YO26 4ZH

MIDLANDS

Corby	0330 119 2639	sales.corby@howarth-timber.co.uk	NN18 8ET
Derby	0330 119 2629	sales.derby@howarth-timber.co.uk	DE1 3QT
Mansfield	0330 119 2619	sales.mansfield@howarth-timber.co.uk	NG19 7JG
Newcastle	0330 119 2569	sales.newcastle@howarth-timber.co.uk	ST5 1AW

LONDON & SOUTH EAST

Dartford	0330 119 2459	sales.dartford@howarth-timber.co.uk	DA1 1BN
London	0330 119 2429	sales.london@howarth-timber.co.uk	SE4 2LY
Tottenham	0330 119 2469	sales.tottenham@howarth-timber.co.uk	N17 6RA

HOWARTH GREENHOUSE

Rochdale	01706 356 230	greenhouse@howarth-timber.co.uk	OL16 2AA
----------	---------------	---------------------------------	----------

HOWARTH TIMBER ENGINEERED SOLUTIONS

Ashton	0161 339 4581	ashton_enquiry@howarth-timber.co.uk	OL7 0AG
Brighton	01757 288 300	brighton_enquiry@howarth-timber.co.uk	YO8 6LY
Bury St. Edmunds	01284 772 700	buryse_enquiry@howarth-timber.co.uk	IP32 7QW
Fairford	01285 711 600	fairford_enquiry@howarth-timber.co.uk	GL7 4DS

HOWARTH WINDOWS & DOORS

New Holland	01469 530 577	windowsanddoors@howarth-timber.co.uk	DN19 7RT
-------------	---------------	--------------------------------------	----------



For further information email:
info@howarth-timber.co.uk

Visit our comprehensive website:
www.howarth-timber.co.uk